



INTRODUCTION

CONNECTION

PREPARATIONS AND MAIN FUNCTIONS

CAMERA ADJUSTMENTS

MENU OPERATION

GENERAL

REMOTE CONTROL UNIT

RM-P210

INSTRUCTIONS

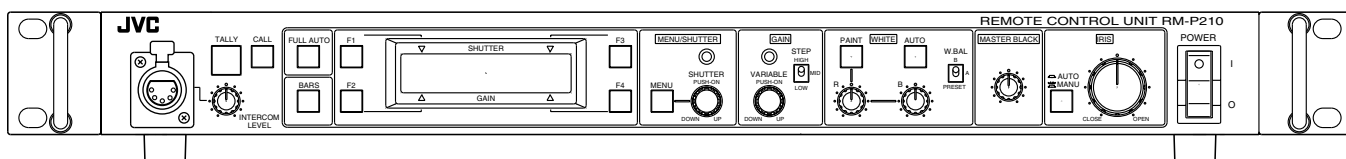

For Customer Use:
Enter below the Model No. and Serial No. which are located on the bodie.
Retain this information for future reference.

Model No. RM-P210

Serial No. _____

IMPORTANT SAFEGUARDS

1. Read all of these instructions.
2. Save these instructions for later use.
3. All warnings on the product and in the operating instructions should be adhered to.
4. Unplug this appliance system from the wall outlet before cleaning. Do not use liquid cleaners or aerosol cleaners. Use a damp cloth for cleaning.
5. Do not use attachments not recommended by the appliance manufacturer as they may cause hazards.
6. Do not use this appliance near water – for example, near a bathtub, washbowl, kitchen sink, or laundry tub, in a wet basement, or near a swimming pool, etc.
7. Do not place this appliance on an unstable cart, stand, or table. The appliance may fall, causing serious injury to a child or adult, and serious damage to the appliance.
Use only with a cart or stand recommended by the manufacturer, or sold with the appliance. Wall or shelf mounting should follow the manufacturer's instructions, and should use a mounting kit approved by the manufacturer.
An appliance and cart combination should be moved with care. Quick stops, excessive force, and uneven surfaces may cause the appliance and cart combination to overturn.
8. Slots and openings in the cabinet and the back or bottom are provided for ventilation, and to insure reliable operation of the appliance and to protect it from overheating, these openings must not be blocked or covered. The openings should never be blocked by placing the appliance on a bed, sofa, rug, or other similar surface. This appliance should never be placed near or over a radiator or heat register. This appliance should not be placed in a built-in installation such as a bookcase unless proper ventilation is provided.
9. This appliance should be operated only from the type of power source indicated on the marking label. If you are not sure of the type of power supplied to your home, consult your dealer or local power company. For appliance designed to operate from battery power, refer to the operating instructions.
10. This appliance system is equipped with a 3-wire grounding type plug (a plug having a third (grounding) pin). This plug will only fit into a grounding-type power outlet. This is a safety feature. If you are unable to insert the plug into the outlet, contact your electrician to replace your obsolete outlet. Do not defeat the safety purpose of the grounding plug.
11. For added protection for this product during a lightning storm, or when it is left unattended and unused for long periods of time, unplug it from the wall outlet and disconnect the antenna or cable system. This will prevent damage to the product due to lightning and power-line surges.
12. Do not allow anything to rest on the power cord. Do not locate this appliance where the cord will be abused by persons walking on it.
13. Follow all warnings and instructions marked on the appliance.
14. Do not overload wall outlets and extension cords as this can result in fire or electric shock.
15. Never push objects of any kind into this appliance through cabinet slots as they may touch dangerous voltage points or short out parts that could result in a fire or electric shock. Never spill liquid of any kind on the appliance.
16. Do not attempt to service this appliance yourself as opening or removing covers may expose you to dangerous voltage or other hazards. Refer all servicing to qualified service personnel.
17. Unplug this appliance from the wall outlet and refer servicing to qualified service personnel under the following conditions:
 - a. When the power cord or plug is damaged or frayed.
 - b. If liquid has been spilled into the appliance.
 - c. If the appliance has been exposed to rain or water.
 - d. If the appliance does not operate normally by following the operating instructions. Adjust only those controls that are covered by the operating instructions as improper adjustment of other controls may result in damage and will often require extensive work by a qualified technician to restore the appliance to normal operation.
 - e. If the appliance has been dropped or the cabinet has been damaged.
 - f. When the appliance exhibits a distinct change in performance – this indicates a need for service.
18. When replacement parts are required, be sure the service technician has used replacement parts specified by the manufacturer that have the same characteristics as the original part. Unauthorized substitutions may result in fire, electric shock, or other hazards.
19. Upon completion of any service or repairs to this appliance, ask the service technician to perform routine safety checks to determine that the appliance is in safe operating condition.

PORTABLE CART WARNING
(symbol provided by RETAC)



S3126A

SAFETY PRECAUTIONS



CAUTION
RISK OF ELECTRIC SHOCK
DO NOT OPEN



CAUTION : TO REDUCE THE RISK OF ELECTRIC SHOCK,
DO NOT REMOVE COVER (OR BACK).
NO USER SERVICEABLE PARTS INSIDE.
REFER SERVICING TO QUALIFIED SERVICE PERSONNEL.

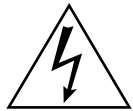

The lightning flash with arrowhead symbol, within an equilateral triangle is intended to alert the user to the presence of uninsulated "dangerous voltage" within the product's enclosure that may be of sufficient magnitude to constitute a risk of electric shock to persons.



The exclamation point within an equilateral triangle is intended to alert the user to the presence of important operating and maintenance (servicing) instructions in the literature accompanying the appliance.

WARNING: TO REDUCE THE RISK OF FIRE OR ELECTRIC SHOCK, DO NOT EXPOSE THIS APPLIANCE TO RAIN OR MOISTURE.

**AVERTISSEMENT :
POUR EVITER LES RISQUES D'INCENDIE OU D'ELECTROCUTION, NE PAS EXPOSER L'APPAREIL A L'HUMIDITE OU A LA PLUIE.**

Information for USA

This device complies with Part 15 of the FCC Rules. Changes or modifications not approved by JVC could void the user's authority to operate the equipment.

INFORMATION (FOR CANADA) RENSEIGNEMENT (POUR CANADA)

This Class B digital apparatus complies with Canadian ICES-003.

Cet appareil numérique de la class B est conforme à la norme NMB-003 du Canada.

Changes or modifications not approved by JVC could void the user's authority to operate the equipment.

This unit is designed for professional use only.

Due to design modifications, data given in this instruction book are subject to possible change without prior notice.

INTRODUCTION

Thank you for purchasing this JVC product. Before operating this unit, please read the instructions carefully to ensure the best possible performance. These instructions are for RM-P210U.

Contents

INTRODUCTION

Features	4
Provided Accessories and Documents	4
Precautions for Proper Use	4
Controls, Connectors and Indicators	5
Front panel	5
Rear panel	7

CONNECTION

Example of Basic Connection	8
Example of RM-P210 (Connection of 2 units)	9
Camera Setup	10
Turning the Power ON	11

PREPARATIONS AND MAIN FUNCTIONS

Camera Cable Length Setup	12
Adjustments for Genlock Operation	13
Intercom	14
Camera Operator Call	14
Tally Input	14
Function Keys	15

CAMERA ADJUSTMENTS

Shutter Speed Adjustment	16
Gain Adjustment	16
Iris Adjustment	17
White Balance Adjustment	18

MENU OPERATION

Flow of Menus	19
Menu Setup Method	20
GENLOCK Menu	21
CABLE Menu	21
FILE Menu	22
PROCESS Menu	23
OPERATION Menu	25
LCD MODE Menu	26
SYSTEM RESET Menu	27

GENERAL

Warning Messages	28
Error Messages	28
Functions Available Depending on Camera Models	29
Troubleshooting	30
Specifications	31

INTRODUCTION

FEATURES

● Cable extension up to 100 meters

The cable between the camera and the RM-P210 Remote Control Unit can be extended up to 100 meters using the optional VC-P110 series camera cables. Even when the cable is extended, the power to the camera is supplied from the RM-P210 so there is no need to provide a separate power supply for the camera.

● Genlock Function Built In

Genlocking is possible using a composite video (VBS) or a black burst (BB) signal. The SC and H phases can be adjusted from the front panel.

● Camera control using serial communication

The camera control signals are sent by the serial data transmission method.

The camera and the RM-P210 are connected by two data lines so that the CPUs incorporated in the camera and the RM-P210 are in intercommunication, thus facilitating accurate camera control operations.

● Multiple output circuits

In addition to two composite video output circuits (VBS), the R/G/B component signals, Y/R-Y/B-Y component signals or separate Y/C signals (for S-VHS VCR) can be selected according to the purpose or application.

PROVIDED ACCESSORIES AND DOCUMENTS

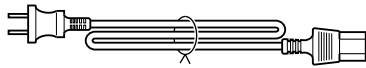

Power cord

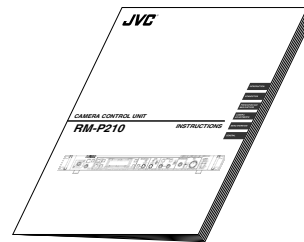

Instructions

PRECAUTIONS FOR PROPER USE

- Do not supply power to the RTS terminals at the rear. These terminals are not designed to accept a power supply.
- To prolong the service life of the **RM-P210**, do not use it or store it in the following places.
 - A place subject to extremely high or low temperatures.
 - A place subject to excessive vibration.
 - A place subject to excessive dust.
 - A place subject to high humidity.
 - A place near to a strong source of noise.
- Do not apply strong vibrations or impact to the **RM-P210** during installation or transportation.
- If the supply voltage is too high or low, the service life of the **RM-P210** may be reduced or it may not be able to provide an optimum performance.
- Do not connect or disconnect the camera cable connector while the **RM-P210** is ON.
- After turning the RM-210 OFF, wait at **least 10 seconds** before turning it ON again.
- Noise may interfere with the video when the RM-210 is installed near a source of strong magnetism, such as a radio or TV transmitting antenna, power transformer or motor.
- While the values set by using the menus are retained in the memory even after the unit is turned off, those set using the front panel switches and controls are retained for about 10 days only and then the factory-set defaults are reset.
- As the LCD contrast is reduced at low temperatures, it should be re-adjusted before use in such conditions.
[REF.] : Item "6A: CONTRAST" on page 26.
- When a transceiver or cellular phone is used near to a RM-210 or to a camera connected to it, noise may interfere with the video. However, this is not a malfunction.
- When an intercom is used, radio interference may occasionally affect any system that is connected to the RM-P210. In such a case the INTERCOM G (GND) terminal provided to the RM-P210 should be grounded.
- In a multiple camera setup, if the adjustments made to the different cameras deviate significantly, the cameras may not be able to function satisfactorily. Be sure to adjust the cameras accordingly before using them with the **RM-P210**.
- Use camera cables with standard lengths, as specified. Otherwise, the camera cable compensation may not be able to work efficiently.
- The RM-P210 can be connected with the following cameras:
 - GY-DV550
 - KY-D29
 - KY-D29W
 - KY-27C
 - KY-19For the viewfinder to be used with each camera model, see page 8. The controllable functions vary depending on the camera model.
[REF.] : "Functions Available Depending on Camera Models" on page 29.
- When connecting the RM-P210 to the camera, do not connect a **local remote controller** to the camera.
- If the RM-P210 is rack-mounted, be sure to insert ventilated panels above and below it in order to improve ventilation. Do not stack two RM-P210 units or place any object on top of a RM-P210 unit.
- To save power consumption, turn the **RM-P210** OFF when it is not in use.

CONTROLS, CONNECTORS AND INDICATORS

■ **Front panel**

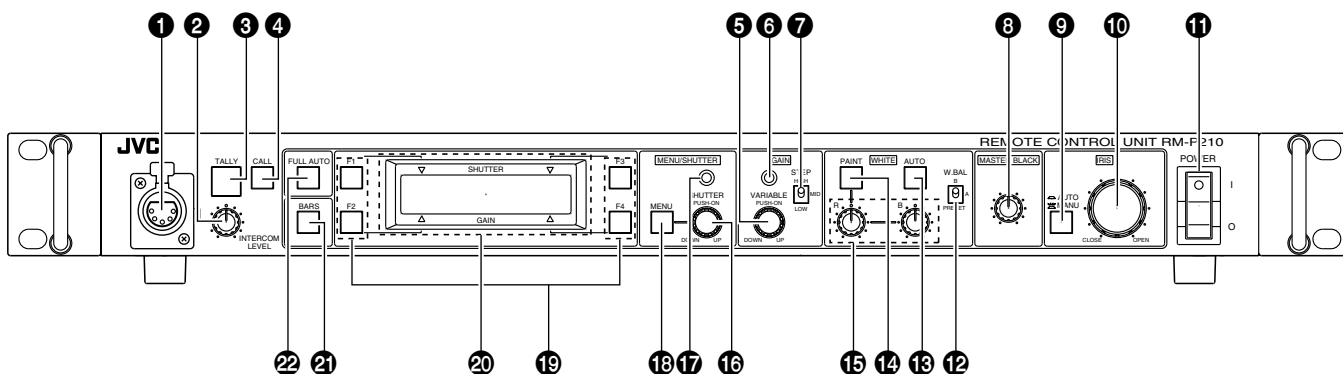

1 Intercom jack

Connect the intercom headset to this jack.

REF. : "Intercom" on page 14.

2 [INTERCOM LEVEL] control

Use this knob to adjust the intercom earphone volume.

3 [TALLY] lamp

This lamp lights when a signal is input to the **TALLY** terminals **2** on the rear panel.

It lights in red when a tally signal is input to the TALLY PGM terminal on the rear panel or in green when a tally signal is input to the TALLY PVW terminal. It blinks in red when there is a CALL signal from the camera.

NOTE

The order of priority among the above signals are; CALL (red blinking), TALLY PGM (red lighting) then TALLY PVW (green lighting).

4 [CALL] button (with lamp)

The camera operator can also be called without using the intercom. When this button is pressed once, the button lamp lights up and the tally lamp on the camera blinks to inform the camera operator of a call. Pressing this button again turns off both the button lamp and tally lamp on the camera.

NOTE

When the CALL button is pressed during VF-P400 operation, the picture on the viewfinder screen may vibrate. However, this is not a malfunction.

5 [GAIN - VARIABLE] control with ON/OFF button

When the button is pressed, the VARIABLE GAIN mode is switched ON and OFF alternately.

The GAIN lamp **6** lights when the VARIABLE GAIN mode is ON.

When the GAIN mode is set to VARIABLE, the GAIN value can be varied from 0.1 dB (or 1.0 dB) to 18 dB in 0.1 dB (or 1.0 dB) steps. The variation per step and the maximum gain value can be changed under the following items.

REF. : Items "5B: V. GAIN STEP" and "5C: V. GAIN MAX" on page 25.

6 [GAIN] lamp

This lamp lights when the gain control is in the VARIABLE GAIN mode.

7 [GAIN - STEP LOW/MID/HIGH] switch

The gain value can be selected according to the position of this switch.

HIGH : **REF.** Gain value set by item "5F: GAIN HIGH" on page 25.

MID : **REF.** Gain value set by item "5E: GAIN MID" on page 25.

LOW : **REF.** Gain value set by item "5D: GAIN LOW" on page 25.

The selected gain value is shown in the **LCD display 20** every time that the position of this switch is changed.

8 [MASTER BLACK] control

Use this knob to adjust the pedestal level, which is the black reference (master black) value.

9 [IRIS - AUTO/MANU] button (with lamp)

When this button is pressed so that the lamp in it lights the lens iris is set to the manual iris control mode. The lens iris level may be adjusted in this mode by using the IRIS control **10**.

When this button is pressed so that the lamp in it turns off, the lens iris is set to the auto iris control mode. The auto iris level can be fine adjusted with the IRIS control **10**.

10 [IRIS - CLOSE-OPEN] control

When the manual iris control mode is set (which is indicated by the lighting of the lamp in the **AUTO/MANU** button **9**), use this knob to adjust the iris aperture between CLOSE and OPEN.

When the iris mode is AUTO (when the lamp in the button is not lit up), the auto iris level can be fine adjusted with this knob.

REF. "Iris Adjustment" on page 17.

INTRODUCTION

CONTROLS, CONNECTORS AND INDICATORS (CONTINUED)

11 [POWER] switch

Press this switch to turn the power ON and OFF.

12 [WHITE - W.BAL B/A/PRESET] switch

This switch switches the white balance control setting between the value stored in Memory **B** (AUTO 2), that stored in Memory **A** (AUTO 1) and the **PRESET** value (3200K). When the white-balance adjustment is **PRESET** and the **PAINT** 14 button is pressed so that the lamp in it lights up, the white-balance adjustment is set to the Manual mode, in which the white-balance can be adjusted with the R/B gain controls 15.

REF. : "White Balance Adjustment" on page 18.

13 [WHITE - AUTO] button (with lamp)

Press this button to start an auto white-balance adjustment of the camera (within a second). This button is activated only when the W.BAL switch is set to "A" or "B".

When the camera in use has the AUTO SETUP function, pressing and holding this button for more than a second initiates the AUTO SETUP mode and then starts the auto black-balance and auto white-balance adjustment operations. If the camera does not have an AUTO SETUP function, pressing and holding this button for more than a second starts only the auto white-balance adjustment operation.

REF. : "White Balance Adjustment" on page 18.

NOTE

- When the camera performs the auto white operation or other AUTO SET operations, the lamp in this button normally lights up and turns off when the camera completes the operation. If the adjustment has not been done correctly, the LCD display shows an error message.
- The lamp in this button also lights up when the FAW (Full-time Auto White-balance) adjustment function of the camera is functioning.

14 [WHITE - PAINT] button (with lamp)

When this button is pressed so that the lamp in it lights up, the **R** and **B** gain values can be adjusted using the **R** and **B** controls 15. If the **W.BAL** switch 12 is set to "A" or "B", the white paint adjustment (fine adjustment of the **R** and **B** gain) can be performed using the **R** and **B** controls 15.

If the **W.BAL** switch 12 is set to **PRESET**, the lamp in this button lights up and the **R** and **B** controls can vary the **R** and **B** gain values by a larger amount than usual 15.

15 [WHITE - R/B] gain controls

R : Use this knob to fine-adjust the **R** gain during the white paint operation or adjust the **R** gain during manual white balance adjustment.

B : Use this knob to fine-adjust the **B** gain during the white paint operation or adjust the **B** gain during manual white balance adjustment.

REF. : "White Balance Adjustment" on page 18.

16 [SHUTTER] control with ON/OFF button

When this knob is pressed, the shutter speed variation function is turned alternately ON and OFF.

When the shutter speed variation is ON, the **SHUTTER** lamp 17 lights and turning the knob will vary the shutter speed.

In **STEP** mode the shutter speed is varied in stages, fine adjustments can be made in **VARIABLE** mode.

REF. : Item "5A: SHUTTER" on page 25.

When the **MENU** lamp 18 is lit, turn the knob to switch between menu items, press the knob (to the ON position) to select an item.

REF. : "Menu Setup Method" on page 20.

17 [SHUTTER] lamp

This lamp lights up to indicate that the shutter speed variation facility is ON.

Adjust the shutter speed using the **SHUTTER** control 16.

18 [MENU] button (with lamp)

When this button is held depressed for about 1 second, the button lamp is lit and the menu becomes variable. (The **SHUTTER** and **GAIN** lamps should be off.)

Pressing this button terminates a menu and turns the lamp in the button off.

REF. : "Menu Setup Method" on page 20.

19 [F1 to F4] function keys

Each of these keys can turn the function assigned to it alternately ON and OFF.

REF. : "Function Keys" on page 15.

20 LCD display

This panel shows the **SHUTTER** and **GAIN** settings as well as the functions assigned to the function buttons.

This panel is also used to show menus and various operation messages.

21 [BARS] button (with lamp)

When this button is pressed, the lamp in it lights up and the RM-P210 outputs the color bar signal. This signal is used during genlock operation.

REF. : "Adjustments for Genlock Operation" on page 13.

22 [FULL AUTO] button (with lamp)

When this button is pressed, the lamp in it lights up and the **RM-P210** enters the FAS (Full-Auto Shooting) mode. Pressing the button again turns the lamp off.

In the FAS mode, the **BARS** mode is switched OFF, and the auto level control, auto iris control and full-auto white balance control functions are performed automatically in an integrated manner.

For details, please read the description of the FAS function in the manual of the camera in use.

The functions that can be controlled are variable depending on which camera model is connected.

REF. : "Function Available Depending on Camera Models" on page 29.

CONTROLS, CONNECTORS AND INDICATORS (CONTINUED)

■ **Rear panel**

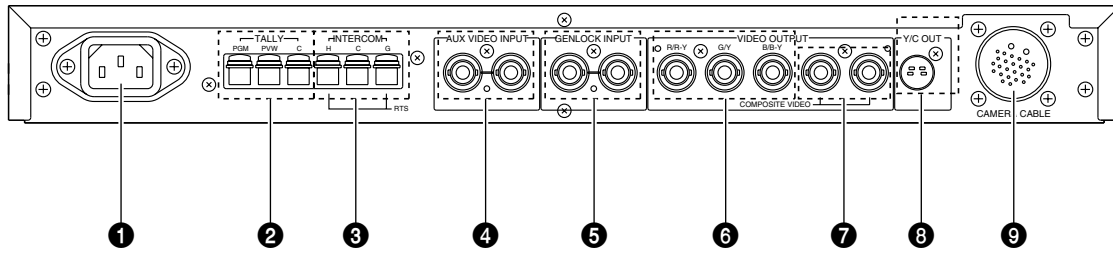

1 [AC ~ IN] connector

Connect this socket to a commercial power supply outlet using the power cord provided.

2 [TALLY] terminals

These terminals input the tally signals.

- When the contact between the PGM (Program) and C (Common) terminals is closed, the **TALLY** lamp ③ on the front panel lights in **RED**.
- When the contact between the PVW (Preview) and C (Common) terminals is closed, the **TALLY** lamp ③ on the front panel lights in **GREEN**.

REF. : “Tally Input” on page 14.

3 [INTERCOM] terminals

These terminals input and output the intercom signals. In a system composed of multiple cameras and remote control units, the intercom function provides intercommunication between operators.

REF. : “Intercom” on page 14.

4 [AUX VIDEO INPUT] connectors

These connectors are used to input the return video signal, which returns the SEG (Special Effects Generator) or switcher output signal to the camera viewfinder. The two terminals are loop-through connected inside to enable a bridge connection. They are terminated automatically when they are not bridge-connected.

5 [GENLOCK INPUT] connectors

These connectors are used to input the VBS/BB signal for use in genlocking. They are terminated automatically when they are not bridge-connected.

6 [R/R-Y, G/Y, B/B-Y] component video signal output connectors

The settings of the output signals from these connectors can be switched between RGB, R-Y/Y-B-Y and Y/C using the **SIG SELECT** switch on the camera adapter or by using the menu setup of the camera. When Y/C is selected, the **Y** signal is output from the **G** connector and the **C** signal is output from the **R** connector.

7 [COMPOSITE VIDEO] signal output connectors

These terminals output two lines of VBS (composite video) signals.

8 Y/C OUT connector (4-pin)

This connector outputs the separate Y/C video signals.

NOTE

This connector outputs Y/C signals only when Y/C is selected as the output from the R/R-Y, G/Y and B/B-Y connectors ⑥.

9 [CAMERA CABLE] connector (26-pin)

Connect this socket to a camera using the optionally available camera cables.

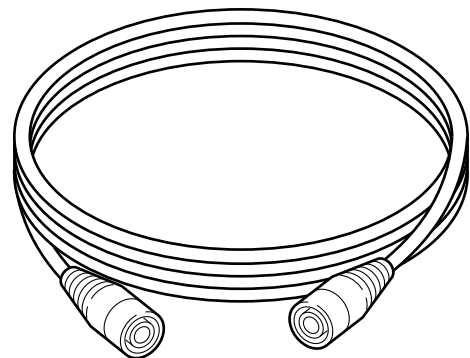

Camera Cables (Optional)

The **VC-P110** series camera cables that can be used to connect a camera to the **RM-P210** are available in four lengths as listed below.

- VC-P110** : 5 meters
- VC-P112** : 20 meters
- VC-P113** : 50 meters
- VC-P114** : 100 meters

A menu setup is required according to the cables in use.

REF. : “Setup of Camera Cable Length” on page 12.

NOTE

- If it is required to extend the cable, use the KA-280 extension connector.
- The total cable length should not exceed 100 meters.

CONNECTION

EXAMPLE OF BASIC CONNECTION

■ Standard connection of the RM-P210 (Connection of a single unit)

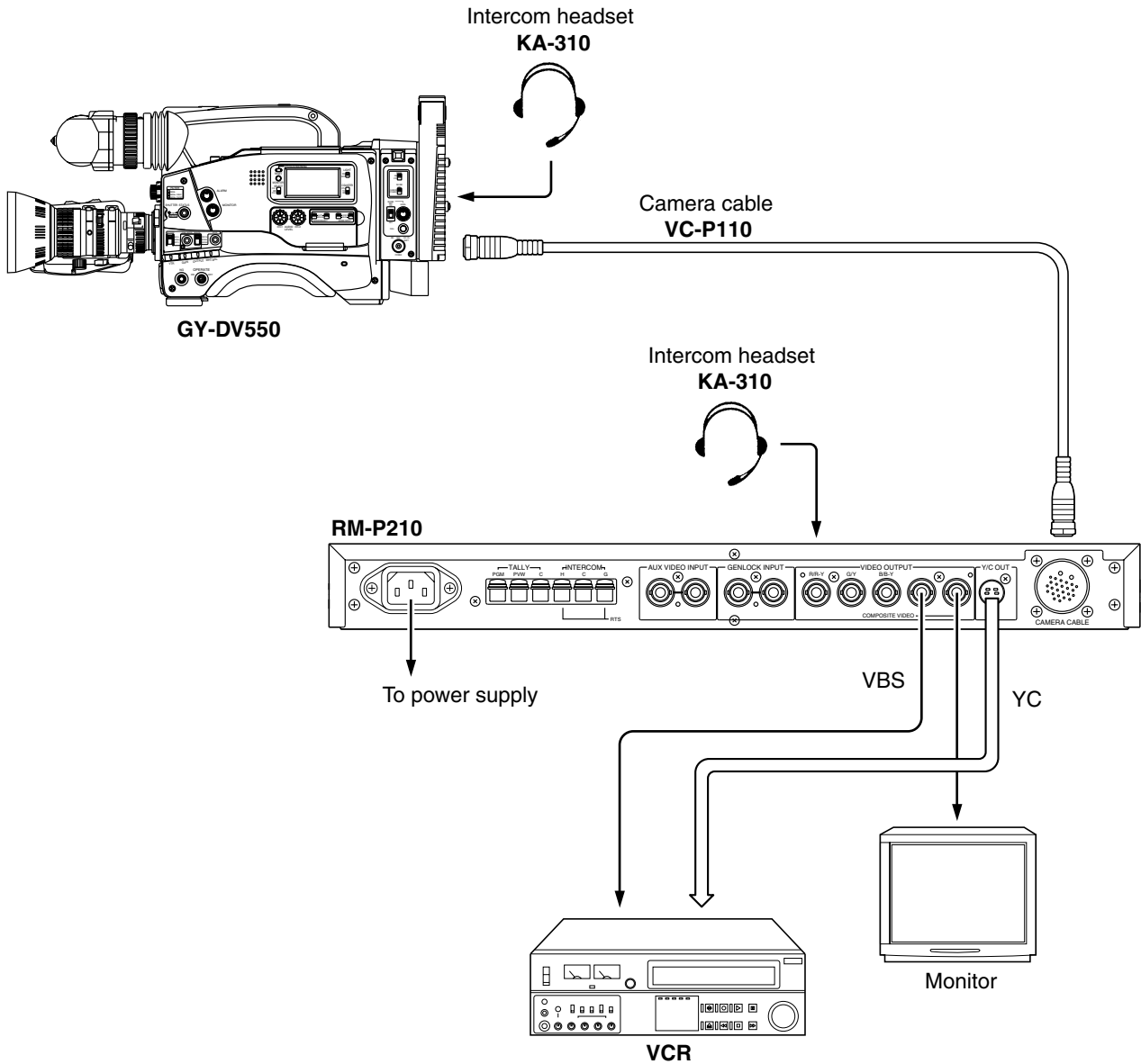

- Connection of Cameras and Viewfinders (○ : Usable, × : Not usable, — : Not connectable)

Viewfinder	VF-P550B	VF-P550W	VF-P400	VF-P115B VF-P115 VF-P116	VF-P116W
Camera					
GY-DV550	×	—	○	○	—
KY-D29	○	—	○	○	—
KY-D29W	—	○	—	—	○
KY-27C KY-19	○	—	○	○	—

- When the RM-P210 is connected to a camera, a local remote controller cannot be connected to the camera.

EXAMPLE OF RM-P210 (CONNECTION OF 2 UNITS)

■ Standard connection of RM-P210 (Connection of 2 units)

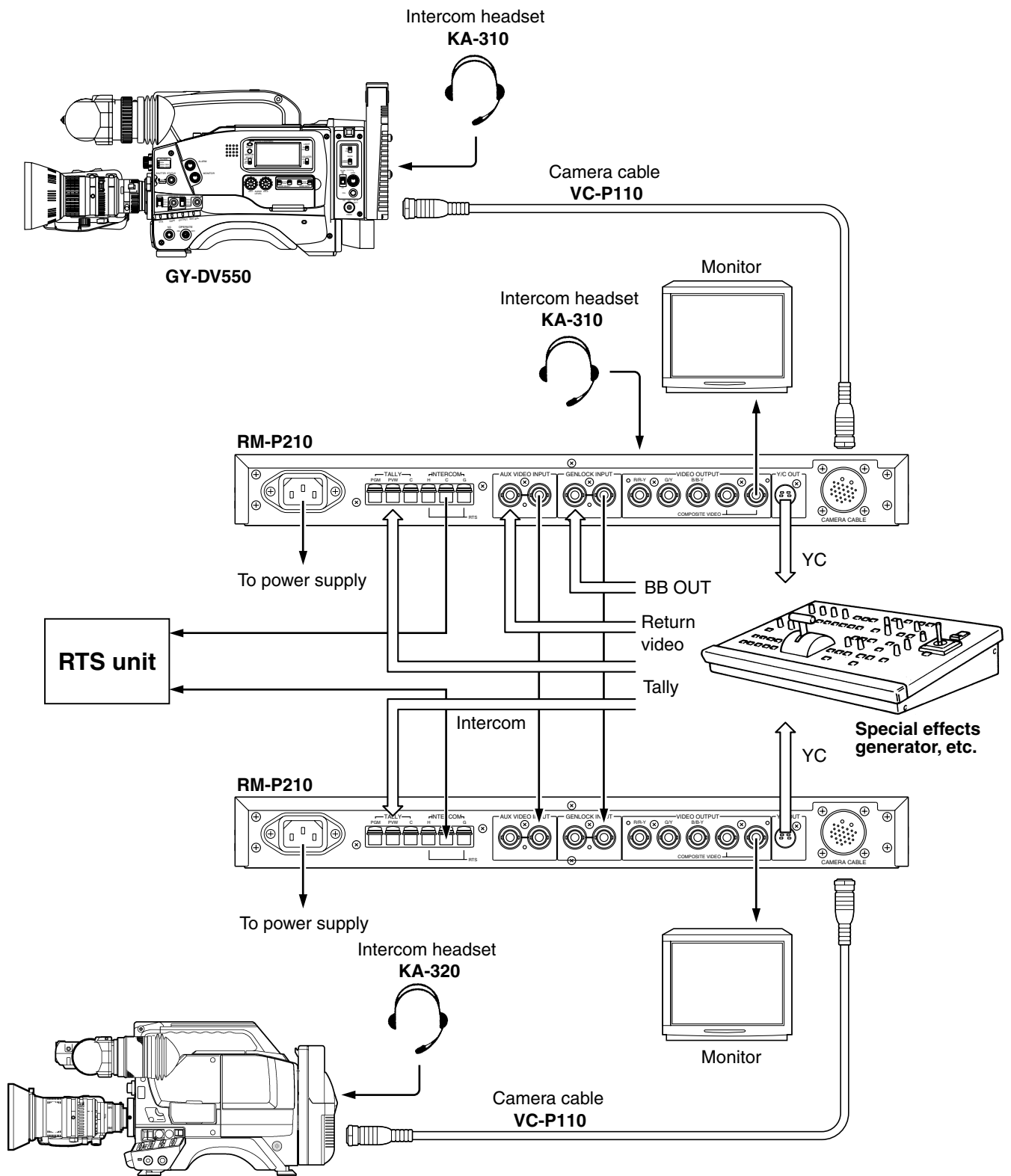

● If more than three RM-P210 units are connected, the intercom volume level will be reduced.

CONNECTION

CAMERA SETUP

Before turning the RM-P210 on, be sure to set up the camera as shown below.

■ GY-DV550 camera

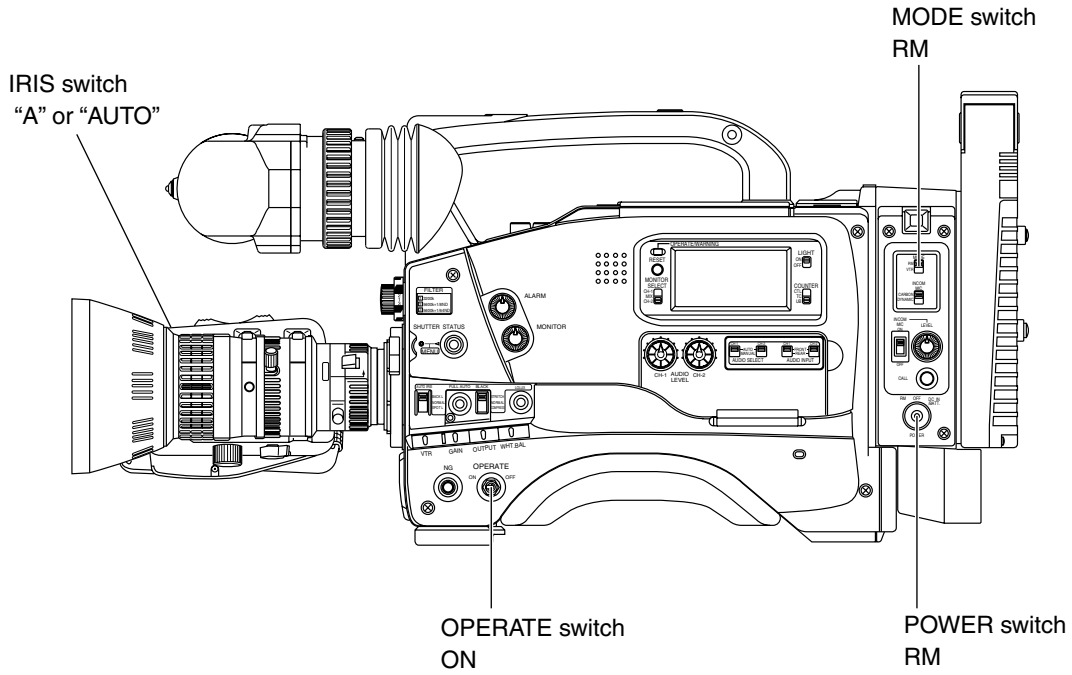

■ KY-D29/KY-D29W camera

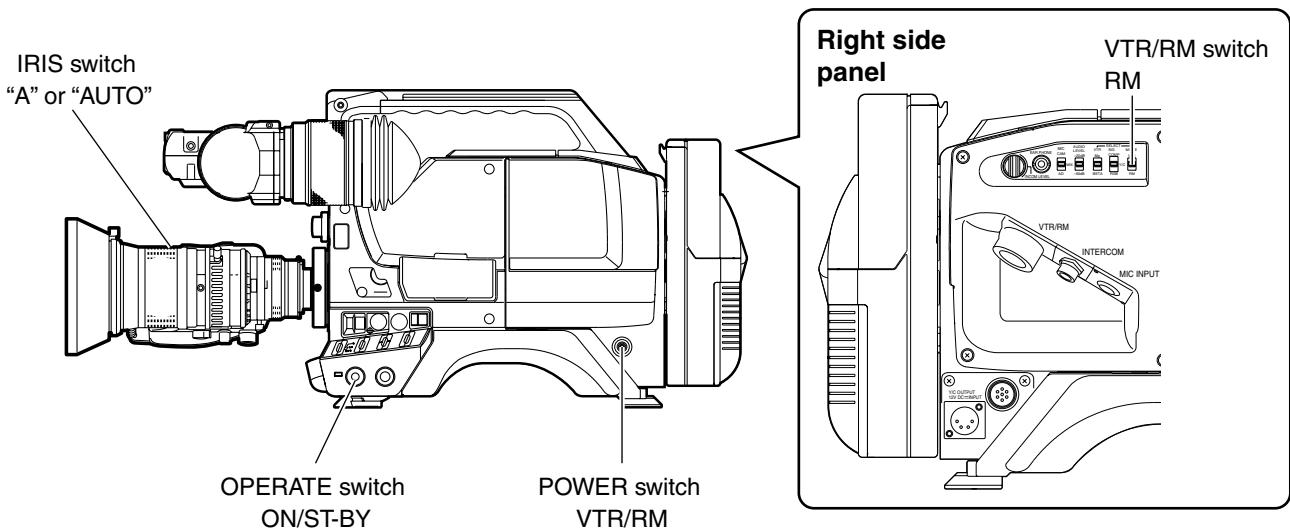

TURNING THE POWER ON

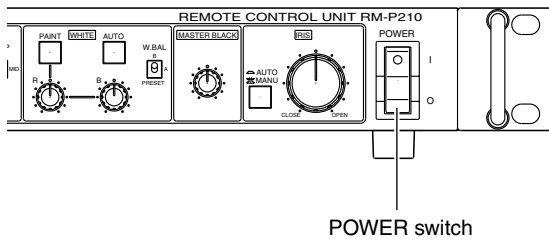

- 1.** Connect the camera to the **RM-P210** using a proper connection method.
- 2.** Set the camera switches as shown on the previous page.
- 3.** Press the POWER switch of the RM-P210 to **ON**.

NOTE

- When an item is controllable from both the RM-210 and the camera, the control from the camera is defeated. Note that the items that are controllable from the RM-210 are variable depending on the camera models.
- When connecting the RM-P210 to the camera, do not connect a local remote controller to the camera.

PREPARATIONS AND MAIN FUNCTIONS

CAMERA CABLE LENGTH SETUP

Cable length setup is required when a camera is connected to the RM-P210 for the first time or when the camera cable length is changed. The cable length setup value is stored in the memory inside the RM-P210 and is held even after it is turned OFF.

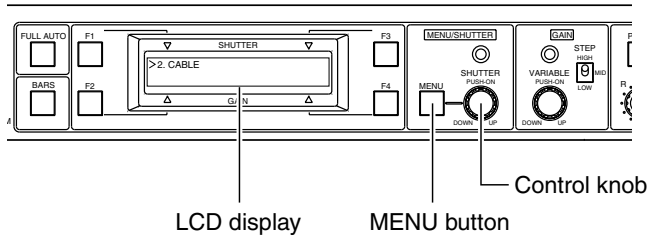

1. Press and hold the **MENU** button for about 1 second until the **LCD display** shows the menu display. Turn the control knob to move the cursor (→) to "2: CABLE".
2. Press the control knob to display "2A: LENGTH".

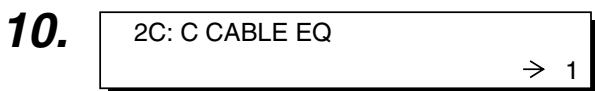
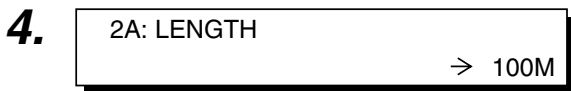
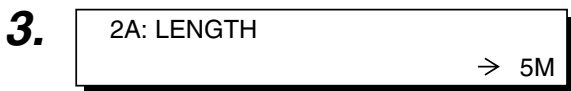
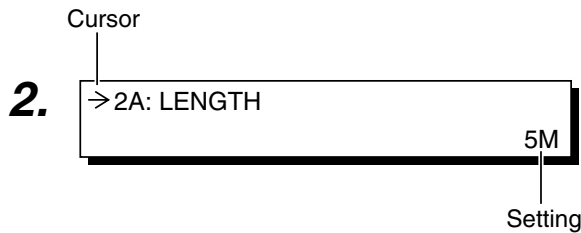
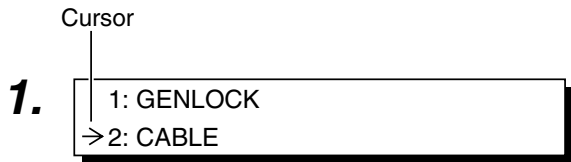

Setting the cable length

3. Press the control knob to move the cursor (→) to the currently set length.
4. Turn the control knob to select the cable length that is to be used in meters (variable to 5M, 20M, 50M or 100M).
5. After setting the value, press the control knob to move the cursor (→) back to "2A: LENGTH".

Fine adjusting the Y (luminance) signal level

6. Turn the control knob to move the cursor (→) to "2B: Y CABLE EQ", then press the control knob to move the cursor (→) to the currently set value.
7. Turn the control knob to fine adjust the Y level (variable from -128 to NORMAL and up to 127).
8. After setting the value, press the control knob to move the cursor (→) back to "2A: LENGTH".

Fine adjusting the C (Chrominance) signal level

9. Turn the control knob to move the cursor (→) to "2C: C CABLE EQ", then press the control knob to move the cursor (→) to the currently set value.
10. Turn the control knob to fine adjust the C level (variable from -128 to NORMAL and up to 127).
11. After setting the cable length, Y level and C level, press the **MENU** button to return to the previous display.

NOTE

When the above adjustment is performed, the color phase (subcarrier phase = SC) varies.

ADJUSTMENTS FOR GENLOCK OPERATION

Genlocking is required for a system, which uses an SEG (special effects generator) as the main signal source.

REF. : “Example of RM-P210 (Connection 2 units)” on page 9.

NOTE

- The following adjustments can be made more accurately when using a vectorscope and waveform monitor.
- Be sure to use an underscanned video monitor.
- It is not permitted to genlock the system components using a VCR playback signal.
- Before phase adjustment, wait a little for the phases of the connected components to stabilize.

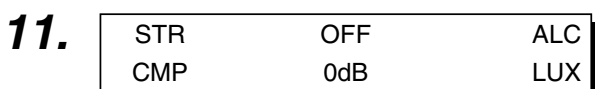
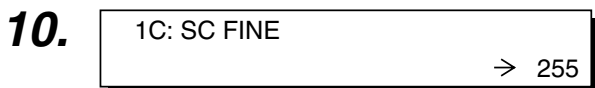
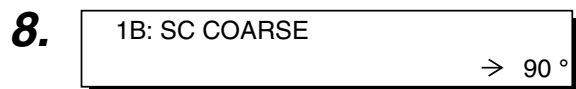
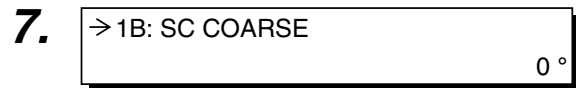
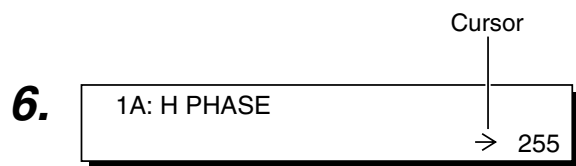
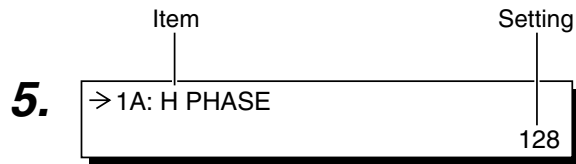
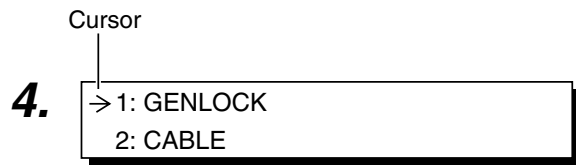
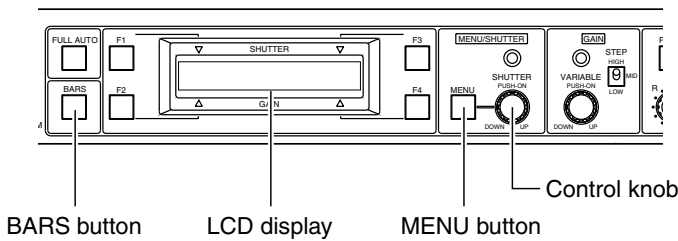

Preparation

1. Press the **BARS** button to output the color bar signal. The button lamp should light up.
2. Output the built-in color bar signal of the SEG from the program connector on the front panel of the SEG. (Refer to the INSTRUCTIONS MANUAL of the SEG.)
3. Observing the monitor screen at the same time, adjust the H PHASE (horizontal phase) and SC (subcarrier phase) while using the switch on the SEG to alternately change between color bars of the internal RM-P210 that of the SEG.

Adjusting the H PHASE

4. Press and hold the **MENU** button for about 3 seconds until the LCD display shows the menu display.
5. Ensure that the cursor (→) is located on “**1: GENLOCK**”, then press the control knob to display “**1A: H PHASE**”.
6. Press the control knob to move the cursor (→) to the currently set value, then turn the control knob to adjust the **H PHASE** value (from 0 to 255). After the adjustment, press the control knob to move the cursor (→) back to “**1: GENLOCK**”.

Adjusting SC phase

7. Turn the control knob to display “**1B: SC COARSE**”.
8. Press the control knob to move the cursor (→) to the currently set value, then turn the control knob to adjust the **SC COARSE** value (to 0°, 90°, 180° or 270°).
9. After the coarse adjustment, press the control knob to move the cursor (→) back to “**1B: SC COARSE**”, then press the control knob to display “**1C: SC FINE**”.
10. Press the control knob to move the cursor (→) to the currently set value, then turn the control knob to adjust the **SC FINE** value (from 0 to 255).

NOTE

If the SC phase cannot be adjusted properly, restart the procedure from the **SC COARSE** adjustment in step 7 again.

11. After the adjustment, press the **MENU** button to return to the previous display.
12. Press the **BARS** button to stop the color bar signal output.

PREPARATIONS AND MAIN FUNCTIONS

INTERCOM

Intercommunications between operators are necessary in a system composed of multiple cameras and remote control units.

Rear panel

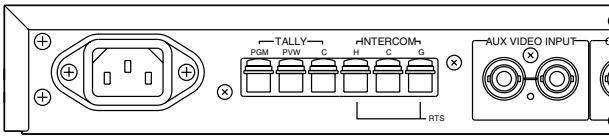

Front panel

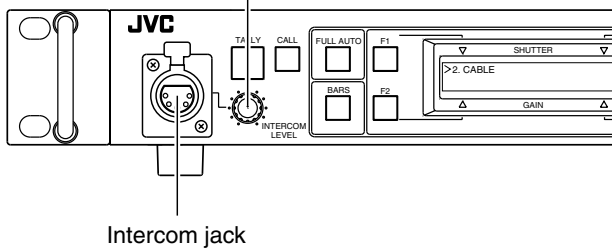

The intercom employs the RTS system.

If it is required to change this to a 2-wire system, consult your nearest JVC-authorized service agent. (The modification will then be carried out with charge.)

An intercom jack is provided on the front panel of the **RM-P210**. The volume level of the headset's earphone can be adjusted using the **INTERCOM LEVEL** control.

NOTE

● Examples of suitable headsets

JVC **KA-310** (Microphone 50 Ω/DC, earphone 150 Ω/1kHz)

Headsets from other manufacturers with:

Microphone output impedance: 50 Ω to 100 Ω

Earphone input impedance: 50 Ω to 300 Ω

- The RM-P210 has been set at the factory to be compatible with a dynamic type headset. If it is required to use a carbon type headset, the setting of the internal circuitry should be changed; consult your nearest JVC-authorized service agent. (The modifications and adjustments will be carried out with charge.)

CAMERA OPERATOR CALL

This function makes it possible to call the camera operator without using the intercom. The camera operator is informed of the call by the blinking of the tally lamp on the camera.

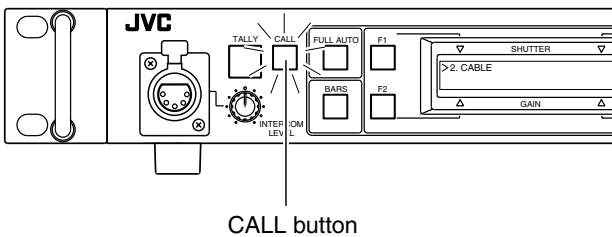

When the **CALL** button is pressed, the button lamp is lit and the tally lamp on the camera blinks. Pressing the button again turns off both the button lamp and the blinking of the camera's tally lamp.

NOTE

The tally lamp on the camera does not blink or light when either the camera or the **RM-P210** are switched off.

When the **CALL** button of the camera is pressed, the **TALLY** lamp of RM-P210 blinks in red.

TALLY INPUT

The **TALLY** lamp on the front panel lights when signals are applied to the **TALLY** input terminals on the rear panel.

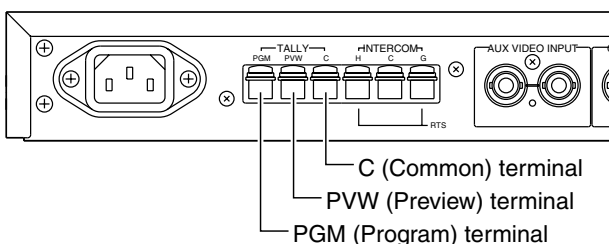

- The **TALLY** lamp lights in **red** when contact is made between the PGM (Program) and C (Common) terminals.

- The **TALLY** lamp lights in **green** when contact is made between the PVW (Preview) and C (Common) terminals.

NOTE

The RM-P210 has been set at the factory in the "make contact mode". If it is required to set it to the "voltage supplied mode", the setting of the internal circuitry should be changed; consult your nearest JVC-authorized service agent. (The modification will then be carried out with charge.)

FUNCTION KEYS

Up to four of the functions listed at the bottom of this page can be assigned to function keys F1 to F4 so that each function can be switched on or off by pressing the corresponding key.

(For the assignment of functions: [REF.] Items 5H to 5K, "FUNC1" to "FUNC4" in the OPERATION MENU description on page 25.)

<Example of factory setting>

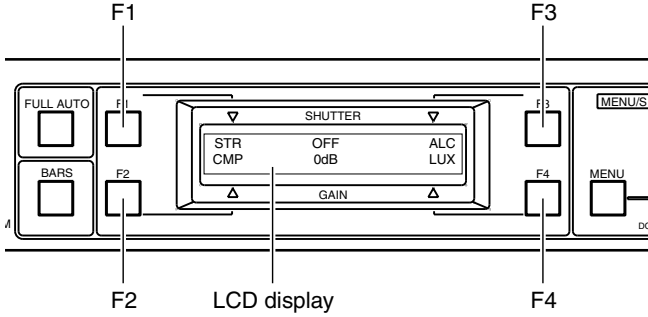

In the example shown on the left, the functions are assigned as shown in the following table.

Key	Display	Function
F1	STR	BLACK STRETCH
F2	CMP	BLACK COMPRESS
F3	ALC	ALC + EEI
F4	LUX	LOLUX

In the figure on the left, the lamps in all the function keys are off, this indicates that all these functions are off.

With certain cameras, "---" may be displayed when none of the above functions are available.

1.

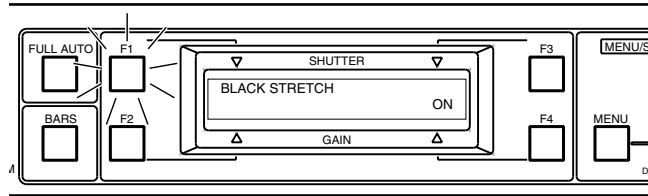

Switching an assigned function on/off

1. When the F1 key is pressed, the **BLACK STRETCH** function assigned to the F1 key is switched from **OFF** to **ON** and the lamp in the key lights up.

NOTE

- The on/off condition of each function key can be set independently.

2.

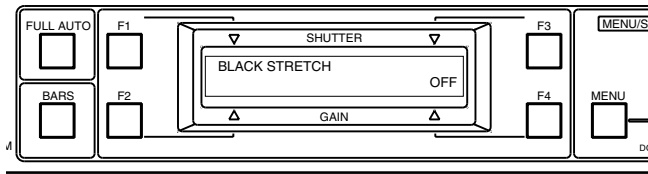

2. When the F1 key is pressed again, the **BLACK STRETCH** function is switched from **ON** to **OFF** and the lamp in the key turns off.

Checking the assigned functions

Press the **MENU** button to display the functions assigned to the function keys for about 3 seconds, in up to 7 characters per function as shown in the figure on the left.

NOTE

When **BLACK STRETCH** and **BLACK COMPRESS** are assigned to two of the F1 to F4 keys, it is not permitted to switch the two functions ON simultaneously. It is not permitted to switch both **ALC+EEI** and **LOLUX** ON.

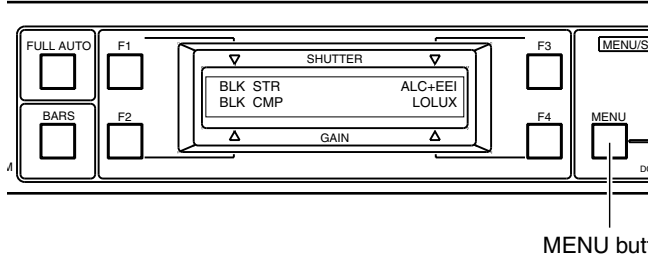

Function Name	Display (3-Character)	Display (7-Character)
NONE	---	-----
BLACK STRETCH	STR	BLK STR
BLACK COMPRESS	CMP	BLK CMP
ALC + EEI	ALC	ALC + EEI
LOLUX	LUX	LOLUX
FAW	FAW	FAW
AUTO KNEE	KNE	AT KNEE
SKIN DETAIL	SKN	SKN DTL
COLOR MATRIX	MAT	COL MAT
DETAIL	DTL	DETAIL
DNR	DNR	DNR

CAMERA ADJUSTMENTS

SHUTTER SPEED ADJUSTMENT

Turning the SHUTTER control can vary the shutter speed of the camera. The LCD display shows the shutter speed during the adjustment operation.

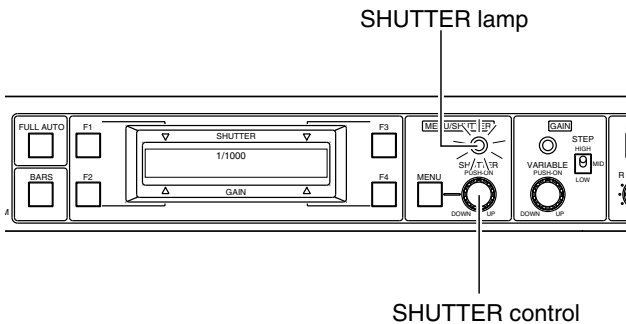

1. Press the **SHUTTER** control to activate the shutter speed variation facility, which is indicated by the lighting of the **SHUTTER** lamp.
2. Turn the **SHUTTER** control to vary the shutter speed. The LCD display shows the shutter speed during the adjustment operation. The shutter speed can be adjusted in either **STEP** mode for adjustments in steps or in **VARIABLE** mode for fine adjustments.

REF. : ● Item “5A: SHUTTER” on page 25.
● “Functions available depending on camera models” on page 29.

STEP : This mode allows the shutter speed to be set to one of the following fixed values.
(Variation steps: 1/100, 1/250, 1/500, 1/1000, 1/2000)

VARIABLE: Use this mode when shooting an image on a computer monitor, etc.
(Variation range: approx 1/60 to 1/2000)

* The fixed values are variable depending on the camera in use.

NOTE

- The variation range is variable depending on the camera in use.
- The shutter speed displayed on the RM-P210 may be slightly different from the actual shutter speed of the camera.

NOTE

- When the FULL AUTO (Full Auto Shooting) is ON, the shutter speed becomes EEI. However, the shutter speed is OFF in the LoLux mode. When FAS is ON, the SHUTTER control cannot be used to vary the shutter speed.
- When ALC+EEI is ON, the shutter speed becomes EEI. At this time, the SHUTTER control cannot be used to vary the shutter speed.

GAIN ADJUSTMENT

When the illumination of the object is insufficient, the electrical gain can be boosted as described below.

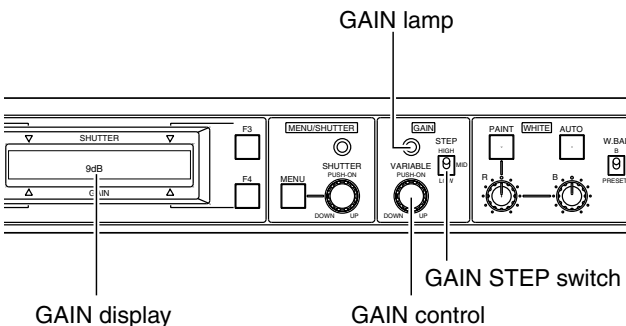

1. The gain is boosted according to the position of the **GAIN STEP** switch as shown below. (The gain boost values shown below are factory settings.)

LOW : 0 dB (No gain boost)

MID : 9 dB (Gain approximately tripled.)

HIGH: 18 dB (Gain approximately octupled.)

The gain boost values of these switch positions can be modified to the following values.

(Available values: -3 dB, 0 dB, 3 dB, 6 dB, 9 dB, 12 dB, 18 dB)

REF. : Items 5D to 5F, “GAIN LOW, MID and HIGH” on page 25.

NOTE

The variable values vary depending on the connected camera model.

REF. : “Functions available depending on camera models” on page 29.

2. When the GAIN control is pressed, the VARIABLE mode starts and the GAIN lamp lights up.

NOTE

The gain value set in the VARIABLE mode is applied in priority over the gain switch setting.

3. The gain can be fine adjusted between 0.1 dB and 18 dB in 0.1 dB steps in the VARIABLE mode. Also, in this mode, the maximum gain value can be set to 9 dB, 12 dB or 18 dB. When the variation step is set to 1.0 dB, the gain can be varied from 1 dB to 18 dB in 1 dB steps.

REF. : Item “5B: V.GAIN STEP” and “5C: V. GAIN MAX” on page 25.

IRIS ADJUSTMENT

The camera lens iris can be adjusted from the RM-P210.

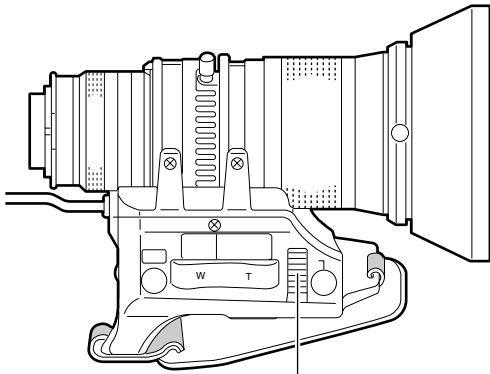

Iris MODE switch

1. When the lamp in the IRIS **AUTO/MANU** button is not lit, the iris control is set to **AUTO** mode, in which the iris level is controlled automatically according to the light intensity. The auto iris value cannot be adjusted with the IRIS control.
2. When the lamp in the IRIS **AUTO/MANU** button is lit by pressing the button, the iris control is set to **MANUAL** mode, in which the iris level can be controlled using the **IRIS** control.

NOTE

When ALC+EEI or FULL AUTO is ON, the AUTO/MANUAL button is forced to the AUTO mode.

REF. : Consult the **INSTRUCTION MANUAL** of the camera in use.

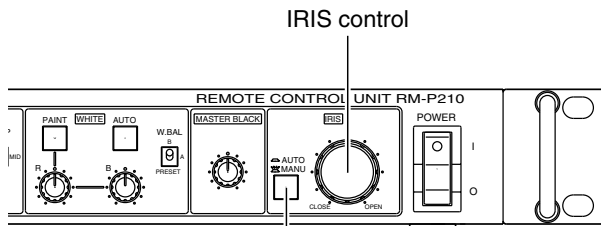

IRIS control

IRIS AUTO/MANU button

CAMERA ADJUSTMENTS

WHITE BALANCE ADJUSTMENT

Since color temperature varies depending on the light source, the white balance should be adjusted whenever the main light source illuminating the object being shot changes.

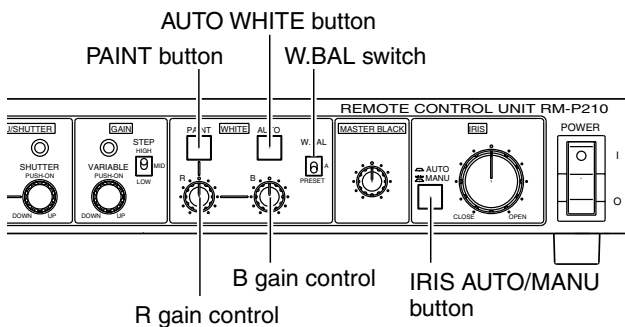
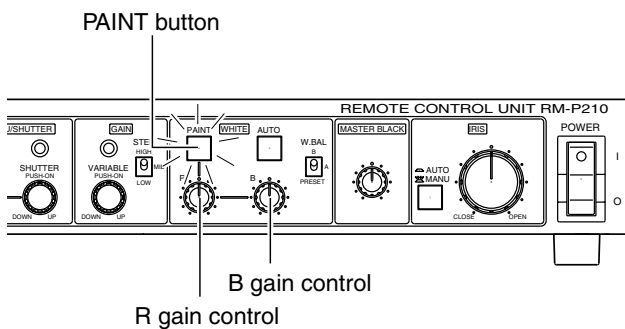
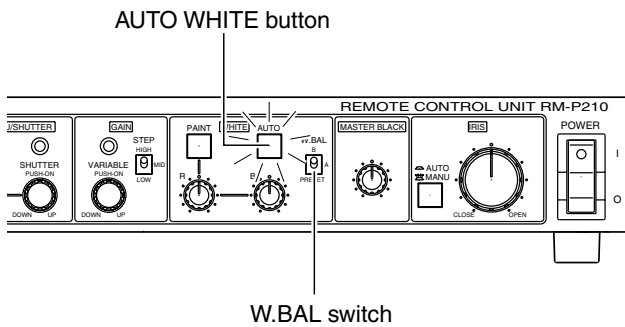

AUTO white balance adjustment (AUTO SETUP)

1. Press the **W.BAL** switch to select memory “**B**” or “**A**”.
2. Press the **AUTO WHITE** button to start the auto white-balance adjustment of the camera within a second. When the connected camera has an **AUTO SETUP** function, pressing and holding the button for more than a second initiates the **AUTO SETUP** mode and starts the auto black-balance and auto white-balance adjustment operations. When the camera does not have the **AUTO SETUP** function, it is only the auto white-balance adjustment that is started by this button.

When the white balance is adjusted properly, the LCD display shows “**AUTO WHITE A(B) OK**”.

NOTE

- The lamp in the button lights up during an auto white-balance adjustment or an auto setup of the camera and turns off when it completes.
- The lamp in the button also lights up when the **FAW** (Full Auto White) balance adjust function of the camera is working.
- The LCD display shows the operating status of the auto white balance adjustment or auto setup operation. If the white balance is not adjusted properly, the LCD display shows an error message.

REF. : “**ERROR MESSAGES**” on page 28.

White paint operation

This can be performed after completion of the auto white balance adjustment and enables the fine adjustment of the white balance using the **R** and **B** gain controls.

3. Press the **PAINT** button so that the button lamp lights up.
4. While observing the color monitor screen, finely adjust the **R** and **B** gain levels using their respective controls.

NOTE

- The white paint operation is not capable of making large variations in the **R** and **B** gain levels.
- The white paint operation is turned **OFF** automatically when the auto white balance adjustment is started.

MANUAL white balance adjustment

This function enables the manual adjustment of the white balance using the **R** and **B** gain controls.

Use an oscilloscope or waveform monitor for this adjustment.

1. Set the **W.BAL** switch to “**PRESET**”.
2. Press the **PAINT** button so that the lamp in it turns off, indicating the manual white balance adjust mode.
3. While observing the oscilloscope or waveform monitor, adjust the **R** and **B** gain levels using their respective controls.

NOTE

When **FULL AUTO** or **FAW** is **ON**, the white balance adjustment becomes the **FAW** (Full-time Auto White) mode. In this mode, the **AUTO** lamp lights and all of the white balance-related operation (**GAIN** control, **W. BAL** switch or **PAINT**) are defeated.

MENU OPERATION

FLOW OF MENUS

The menus displayed on the RM-210 are provided in the form shown below. The displayed items and values are variable depending on the connected camera model. (The items and values that are not available with the camera are not displayed.)

Category	Item	Variable value
1: GENLOCK (☞ Page 21)	1A: H PHASE	0 to 255
	1B: SC COARSE	0°, 90°, 180°, 270°
	1C: SC FINE	0 to 255
	1Z: BACK	
2: CABLE (☞ Page 21)	2A: LENGTH	5M, 20M, 50M, 100M
	2B: Y CABLE EQ	-128 to NORMAL to 127 (This value is retained according to LENGTH)
	2C: C CABLE EQ	-128 to NORMAL to 127 (This value is retained according to LENGTH)
	2Z: BACK	
3: FILE (☞ Page 22)	3A: READ FILE	A, B, BACK
	3B: WRITE FILE	A, B, BACK
	3C: RESET FILE	A, B, BACK
	3Z: BACK	
4: PROCESS (☞ Page 23)	4A: DETAIL	OFF, ON
	4B: DETAIL LEVEL	-10 to NORMAL to 10
	4C: DETAIL V/H	-10 to NORMAL to 10
	4D: DETAIL FRQ.	LOW, MIDDLE, HIGH, AUTO
	4E: SKIN DETAIL	OFF, ON
	4F: AUTO KNEE	OFF, ON
	4G: KNEE POINT	-10 to NORMAL to 10
	4H: COLOR MATRIX	OFF, ON
	4I: V.RESOLUTION	NORMAL, V.MAX
	4J: GAMMA	OFF, ON
	4K: GAMMA LEVEL	-10 to NORMAL to 10
	4L: BLACK	NORMAL, STRETCH, COMPRESS
	4M: ASPECT RATIO	4:3, 16:9, LETTER
	4N: DNR	OFF, ON
	4O: DNR LEVEL	LOW, MIDDLE, HIGH, AUTO
	4Z: BACK	
5: OPERATION (☞ Page 25)	5A: SHUTTER	STEP, VARIABLE
	5B: V. GAIN STEP	0.1 dB, 1.0 dB
	5C: V. GAIN MAX	9.0 dB, 12.0 dB, 18.0 dB
	5D: GAIN LOW	-3 dB, 0 dB, 3 dB, 6 dB, 9 dB, 12 dB, 18 dB
	5E: GAIN MID	-3 dB, 0 dB, 3 dB, 6 dB, 9 dB, 12 dB, 18 dB
	5F: GAIN HIGH	-3 dB, 0 dB, 3 dB, 6 dB, 9 dB, 12 dB, 18 dB
	5G: SMOOTH TRANS	OFF, ON
	5H: FUNC1	*2
	5I: FUNC2	*2
	5J: FUNC3	*2
	5K: FUNC4	*2
	5Z: BACK	
6: LCD MODE (☞ Page 26)	6A: CONTRAST	-5 to NORMAL to 5
	6B: BACKLIGHT	OFF, ON
	6Z: BACK	
7: SYSTEM RESET (☞ Page 27)	7A: SYSTEM RESET	CANCEL, OK.
	7Z: BACK	
8: EXIT		

*1 Check screens are provided for items READ FILE and WRITE FILE.

Netted items are saved in the scene file.

Netted items are saved in the scene file.

*2 The options for FUNC1 to FUNC4 are common:
 BLACK STRETCH, BLACK COMPRESS,
 ALC + EEI, LOLUX,
 FAW, AUTO KNEE,
 SKIN DETAIL, COLOR MATRIX,
 DETAIL, DNR,
 NONE

MENU OPERATION

MENU SETUP METHOD

Each menu is displayed on the LCD display and can be set up using the MENU button and the control knob. The values set in the "4: PROCESS" and "5: OPERATION" menus can be saved in files A and B.

<Example of changing the camera cable length from 20 m to 100 m>

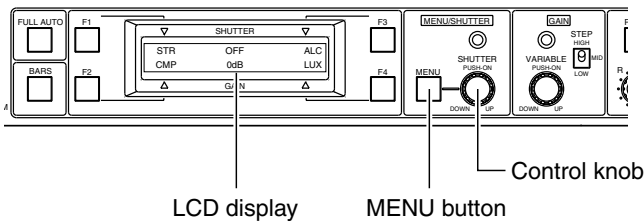

1. Press and hold the MENU button for about 1 second until the LCD display shows the menu display. The cursor (→) indicates that the item being pointed to can be varied.

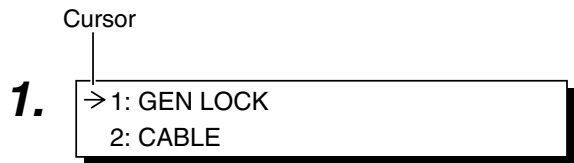

2. Turn the control knob to move the cursor (→) to the desired item.



3. Press the control knob to display the name and current setting of the next item.

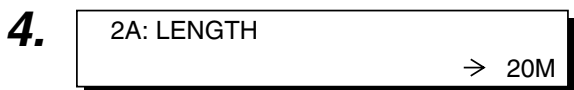

4. Press the control knob to move the cursor (→) to the position of the currently set value.

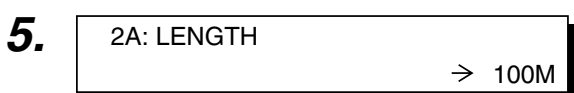

5. Turn the control knob to adjust the setting.

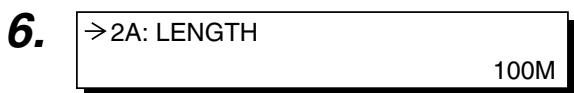

6. Press the control knob to move the cursor (→) back to the item.



7. Turn the control knob to move the cursor (→) to BACK.



8. Press the control knob to return to the previous menu.



9. After completing the setup, move the cursor (→) to "8: EXIT" and press the control knob to return to the normal display.

GENLOCK MENU

This menu is used to set the camera cable length to the length actually used.

(**REF.** : “Adjustments for Genlock Operation” on page 13.)

No.	Item	Function, Operation	Available Settings	Initial Setting
1A	H PHASE	Adjustment of the Horizontal sync phase of genlocking.	0 to 255	128
1B	SC COARSE	Coarse adjustment of the color phase of genlocking. Use a vectorscope, etc.	0°, 90°, 180°, 270°	0°
1C	SC FINE	Fine adjustment of the color phase, which should be performed after completing the SC COARSE adjustment. If the subcarrier cannot be adjusted with SC FINE, restart the adjustment from SC COARSE.	0 to 255	128
1Z	BACK	Return to the previous display.	–	–

CABLE MENU

This menu sets the camera cable length according to the actual length used.

(**REF.** : “Camera Cable Length Setup” on page 12.)

No.	Item	Function, Operation	Available Settings	Initial Setting
2A	LENGTH	Set according to the total length of the camera cables in use.	5M, 20M, 50M, 100M	20M
2B	Y CABLE EQ	Fine adjustment of the luminance signal.	-128 to NORMAL to 127	NORMAL
2C	C CABLE EQ	Fine adjustment of the chrominance component. <div style="border: 1px solid black; padding: 5px; width: fit-content;"> <p>NOTE — This adjustment causes the phase to be altered. Be sure to adjust SC FINE after this adjustment.</p> </div>	-128 to NORMAL to 127	NORMAL
2Z	BACK	Return to the previous display.	–	–

MENU OPERATION

FILE MENU

The values set with the menu and applied to the RM-P210 can be saved in two files named **A** and **B**.

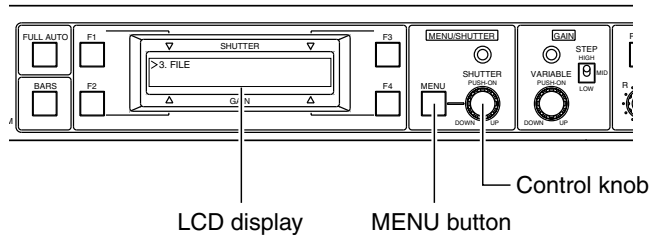

1. Press and hold the **MENU** button for 3 seconds until the **LCD display** shows the menu display. The cursor (⇒) indicates that the item being pointed to can be varied.

1. ⇒ 1: GEN LOCK
2: CABLE

Cursor

2. ⇒ 3: FILE
4: PROCESS

3. ⇒ 3A: READ FILE A

4. ⇒ 3B: WRITE FILE A

5. 3B: WRITE FILE ⇒ A

6. 3B: WRITE FILE ⇒ B

7. WRITE FILE B B
⇒ CANCEL

8. WRITE FILE B B
⇒ OK

9. STR OFF ALC
CMP 0dB LUX

2. Turn the control knob to move the cursor (⇒) to "**3: FILE**".
3. Press the control knob to move the cursor (⇒) below to "**3A: READ FILE**".

Writing data in a file

4. To write data in one of the two files, press the control knob to move the cursor (⇒) to the "**3B: WRITE FILE**".
5. Press the control knob again to move the cursor (⇒) to the position indicating "**A**".
6. To write data in file B, turn the control knob to move the cursor (⇒) to file "**B**".
7. If the control knob is pressed now, the LCD display shows "**WRITE FILE B**" and the cursor (⇒) moves to "**CANCEL**". If it is not required to write data now, the control knob should be pressed again.
8. To write data in a selected file, turn the control knob to move the cursor (⇒) to "**OK**".
9. Press the control knob to write data in a selected file and return to the previous display.

Reading the data in a file

To read previously written data, in step 3. move the cursor (⇒) to "**3A: READ FILE**", then perform the same operations as in steps **4.** to **9.**

Resetting data in a file

To reset saved data to the factory settings, in step 3 move the cursor (⇒) to "**3C: RESET FILE**", then perform the same operations as those in steps **4.** to **9.**

PROCESS MENU

This menu sets the functions built into the camera.

(Some of the following items cannot be set if a local remote control unit is connected to the camera or depending on the connected camera model.)

No.	Item	Function, Operation	Available Settings	Initial Setting
4A	DETAIL	ON/OFF setting of the detail enhancement function. OFF : Detail enhancement is deactivated. ON : Detail enhancement is activated.	OFF ON	ON
4B	DETAIL LEVEL	Adjusts the detail enhancement level. Increasing the level : Sharpens details. Decreasing the level : Softens details.	10 to NORMAL to -10 (21 steps)	NORMAL
4C	DETAIL V/H	Selects whether the detail enhancement is applied more strongly in a horizontal or vertical direction. Increasing the level : Applies detail enhancement more strongly in a H direction. Decreasing the level : Applies low detail enhancement in the H direction. NOTE This item cannot vary the detail enhancement in the V direction.	10 to NORMAL to -10 (21 steps)	NORMAL
4D	DETAIL FRQ	Sets the detail enhancement frequency according to the object. LOW : Low frequency to be used when shooting a coarsely patterned object. MIDDLE : Standard frequency. HIGH : High frequency to be used when shooting a small or finely patterned object. AUTO : Automatic adjustment of the detail enhancement frequency according to the object.	LOW MIDDLE HIGH AUTO	MIDDLE
4E	SKIN DETAIL	ON/OFF setting of the skin tone detail function, which displays natural, wet skin colors by reducing detail enhancement on the skin areas. OFF : Skin tone detail function is deactivated. ON : Skin tone detail function is activated.	OFF ON	OFF
4F	AUTO KNEE	ON/OFF setting whether the auto knee function is activated according to the knee point setting to be made below. OFF : Auto knee function is deactivated. ON : Auto knee function is activated.	OFF ON	ON
4G	KNEE POINT	Sets the knee point level at which the auto knee function is deactivated. Increasing the level : The knee function is activated at a higher video level. Decreasing the level : The knee function is activated at a lower video level. NOTE The actual variation in the knee point occurs step by step because this is set as a result of the knee point setting of the camera.	10 to NORMAL to -10	NORMAL
4H	COLOR MATRIX	ON/OFF setting of whether the color matrix function. OFF : The color matrix function is deactivated. ON : The color matrix function improves the color reproducibility. Note that noise increases with this setting.	OFF ON	ON

MENU OPERATION

PROCESS MENU (CONTINUED)

No.	Item	Function, Operation	Available Settings	Initial Setting
4I	V.RESOLUTION	Increases the vertical resolution. NORMAL : Standard value. V.MAX : Increased value. <div style="border: 1px solid black; padding: 5px; margin-top: 5px;"> NOTE When the vertical resolution is increased, the sensitivity deteriorates and bright areas of objects may appear to be colored. </div>	NORMAL V.MAX	NORMAL
4J	GAMMA	ON/OFF setting of the gamma curve correction, which determines the reproduction of black. OFF : Gamma correction is deactivated. ON : Gamma correction is activated.	OFF ON	OFF
4K	GAMMA LEVEL	Adjusts the gamma correction level. Increasing the level : Improves the reproduction of black but leads to loss of gradation of white. Decreasing the level : To be used when the reproduction of black is not strongly required.	10 to NORMAL to -10	NORMAL
4L	BLACK	Sets the gain in the dark areas according to the captured video signal. NORMAL : Standard gain. STRETCH : Stretches the signals of the dark areas in the image to enhance them and clarify the difference between the bright and dark areas. COMPRESS : When the captured image is bright in overall and has few contrast, the gain of the dark areas is compressed to provide contrast.	NORMAL STRETCH COMPRESS	NORMAL
4M	ASPECT RATIO	Sets the picture size of the video signal. 4:3 : 4:3 screen output. 16:9 : 16:9 screen output. LETTER : Letter size (16:9) screen output.	4:3 16:9 LETTER	4:3
4N	DNR	ON/OFF setting of the DNR (Digital Noise Reduction). OFF : DNR is deactivated. ON : DNR is activated.	OFF ON	OFF
4O	DNR LEVEL	Sets the DNR effect level. LOW : Low DNR level (effective for fast-moving objects). MIDDLE : Standard DNR level (residual image is noticeable). HIGH : High DNR level (residual image is noticeable). AUTO : Automatic adjustment of the DNR level according to the object.	LOW MIDDLE HIGH AUTO	MIDDLE
4Z	BACK	Returns to the previous display.	—	—

OPERATION MENU

This menu sets the functions built into the RM-P210.

No.	Item	Function, Operation	Available Settings	Initial Setting
5A	SHUTTER	Selects whether the front panel SHUTTER control varies the shutter speed in steps or in fine variation. STEP : Shutter speed variation in steps. VARIABLE : Fine, continual variation to be used when shooting a computer monitor, etc.	STEP VARIABLE	STEP
5B	V. GAIN STEP	Selects the step of the gain variation using the GAIN control in the VARIABLE GAIN mode. 0.1 dB : Turning the GAIN control varies the gain in 0.1 dB steps. 1.0 dB : Turning the GAIN control varies the gain in 1.0 dB steps. 0.1 dB	1.0 dB 0.1 dB	0.1 dB
5C	V. GAIN MAX	Selects the maximum gain value in the VARIABLE GAIN mode. 9.0 dB : The GAIN control can vary the gain up to 9.0 dB. 12.0 dB : The GAIN control can vary the gain up to 12.0 dB. 18.0 dB : The GAIN control can vary the gain up to 18.0 dB.	9.0 dB 12.0 dB 18.0 dB	18.0 dB
5D	GAIN LOW	Selects the gain value when the front panel GAIN switch is set to the LOW position.	-3 dB 0 dB 3 dB	0 dB
5E	GAIN MID	Selects the gain value when the front panel GAIN switch is set to the MID position.	6 dB 9 dB 12 dB	9 dB
5F	GAIN HIGH	Selection of the gain value when the front panel GAIN switch is set to the HIGH position. <div style="border: 1px solid black; padding: 5px; width: fit-content; margin: 10px auto;">The KY-D29/KY-D29W enables the GAIN HIGH to be set to 3 dB but this is invalid because the camera itself is not compatible with this setting.</div>	18 dB	18 dB
5G	SMOOTH TRANS	ON/OFF setting of the smooth transition function which prevents sudden change when the position of the GAIN switch or W.BAL switch on the front panel is changed. OFF : SMOOTH TRANS is deactivated. ON : SMOOTH TRANS is activated.	OFF ON	OFF
5H	FUNC1	Sets the function assigned to function key F1 on the front panel.	NONE BLACK STRETCH BLACK COMPRESS	BLACK STRETCH
5I	FUNC2	Sets the function assigned to function key F2 on the front panel.	ALC+EEI LOLUX FAW	BLACK COMPRESS
5J	FUNC3	Sets the function assigned to function key F3 on the front panel.	AUTO KNEE SKIN DETAIL COLOR MATRIX	ALC+EEI
5K	FUNC4	Sets the function assigned to function key F4 on the front panel.	DETAIL DNR	LOLUX
5Z	BACK	Returns to the previous display.	-	-

MENU OPERATION

LCD MODE MENU

This menu sets up the LCD display.

No.	Item	Function, Operation	Available Settings	Initial Setting
6A	CONTRAST	Adjusts the contrast of the LCD display.	5 to NORMAL to -5	NORMAL
6B	BACKLIGHT	Adjusts the setting of the backlight of the LCD display. OFF : Backlight is turned off. ON : Backlight is turned on.	OFF ON	ON
6Z	BACK	Returns to the previous display.	–	–

SYSTEM RESET MENU

This menu resets the values set by the user to the initial values.

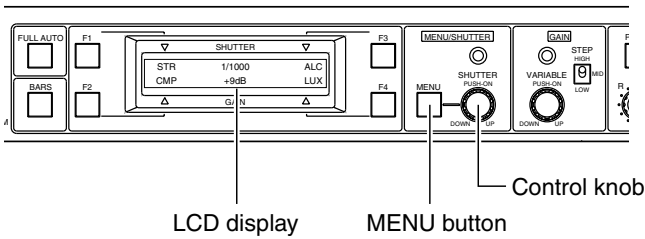

1. 6: LCD MODE
-> 7: SYSTEM RESET

1. Press and hold the MENU button (approx. 1 second) until the LCD display shows the menu display. Then turn the control knob to move the cursor (→) to "7: SYSTEM RESET".

2. → 7A: SYSTEM RESET
CANCEL

2. Press the control knob to display "7A: SYSTEM RESET".

3. 7A: SYSTEM RESET
→ CANCEL

3. Press the control knob to move the cursor (→) to "CANCEL". If you do not want to reset the values you have set, press the control knob now.

4. 7A: SYSTEM RESET
→ OK

4. If you want to reset the values, turn the control knob to move the cursor (→) to "OK".

5. STR OFF ALC
CMP 0dB LUX

5. Press the control knob to reset the values you have set to the initial values and return to the normal display.

Initial values

- The values you've set in the menu items will be reset to the initial values shown on pages 21 to 27.
- Other status settings are reset as shown below.

Status Setting		Initial Values	Status Setting	Initial Values
IRIS button		MANUAL	GAIN	STEP switch
W.BAL switch		Switch position		V.GAIN LEVEL
PAINT button		OFF	SHUTTER	SHUTTER
WHITE PAINT		A Bch Rch <small>Central value of the control</small>		V.SCAN LEVEL
WHITE	MANUAL PAINT	B Bch Rch <small>Central value of the control</small>	FULL AUTO	
			BARS	
			F1 to F4 buttons	
				LOLUX
				ALC+EEI

GENERAL

WARNING MESSAGES

To prevent operational errors, the LCD display shows one of the following warning messages when an erroneous operation is performed.

Displayed Message	Cause	Check Point
INVALID ENTRY GAIN : LOLUX	The gain is set to the LoLux mode.	Exit from the LoLux mode, and then adjust the gain again.
INVALID ENTRY FULL AUTO : ON	The FULL AUTO button is ON.	Press the FULL AUTO button so that the lamp in it turns off, then retry operation.
INVALID ENTRY GAIN : ALC + EEI	ACC+EEI is ON.	Exit from the ACC+EEI mode, and then retry operation.
INVALID ENTRY W.BAL : FAW	The white-balance is set to the FAW mode.	Cancel FAW and start the white-balance adjustment.
INVALID ENTRY W.BAL : PRESET	The W.BAL button is set to PRESET.	Auto white balance adjustment cannot be started in this mode.
INVALID ENTRY W.BAL : MANUAL	The white balance adjustment is set to manual mode by the AUTO/MANU button.	Auto white balance adjustment cannot be started in this mode.
INVALID ENTRY BARS : ON	The BARS button is pressed.	Press the BARS button so that the lamp in it turns off, then retry operation.

ERROR MESSAGES

When the LCD display shows one of the following error messages during an auto white balance adjustment and AUTO SET mode, check “Cause” and “Check Point” below and then retry the auto white balance adjustment. (The error message is displayed for about 5 seconds.)

Displayed Message	Cause	Check Point
AUTO WHITE A (B) ERROR: LOW LIGHT	The light intensity is insufficient.	Increase the lighting (illumination) or boost the gain with the GAIN button. (Note that the sensitivity deteriorates when the gain is boosted.)
AUTO WHITE A (B) NG: OBJECT	The object is not suitable for shooting.	Check if the object is white and change the object if required.
AUTO WHITE A (B) ERROR: OVER LIGHT	<ul style="list-style-type: none"> ● The amount of incident light is too high. ● The color temperature conversion filter is not set properly. 	<ul style="list-style-type: none"> ● Check if a strong light source, such as the sun, is shining into the camera either directly or as a result of a reflection caused by the object. ● Set the color temperature conversion filter to the correct position.
AUTO BLACK LENS NOT CLOSED?	The lens will not close for auto black-balance adjustment.	Set the camera so that the lens can be closed.
AUTO BLACK ERROR!	Auto black adjustment is not working properly.	Check the setups of the RM-210 and camera again.

FUNCTIONS AVAILABLE DEPENDING ON CAMERA MODELS

Function		Connected Model	GY-DV550	KY-D29	KY-D29W	KY-27C KY-19	
IRIS	AUTO IRIS		○	○	○	○	
	AI LEVEL		○	○	○	○	
	MANUAL IRIS		○	○	○	○	
	IRIS LEVEL		○	○	○	○	
MASTER BLACK			○	○	○	○	
WHITE	PRESET		○	○	○	○	
	MANUAL BALANCE		○	○	○	○	
		BALANCE Rch		○	○	○	○
		BALANCE Bch		○	○	○	○
	AUTO A (1)		○	○	○	○	
	AUTO B (2)		○	○	○	○	
	PAINT Rch		○	○	○	○	
	PAINT Bch		○	○	○	○	
	FAW		○	○	○	○	
AUTO	SET		×	○ ^{*1}	○ ^{*1}	○	
	WHITE		○	○	○	○	
GAIN	-3 dB		○	○	○	×	
	0 dB		○	○	○	○	
	3 dB		○	×	×	×	
	6 dB		○	○	○	○	
	9 dB		○	○	○	○	
	12 dB		○	○	○	○	
	18 dB		○	○	○	○	
	ALC + EEI		○	○	○	○	
VARIABLE GAIN		○	×	×	×		
LOLUX	OFF		○	○	○	○	
	ON		○	○	○	○	
SHUTTER	OFF		○	○	○	○	
	1/100		○	○	○	○	
	1/250		○	○	○	○	
	1/500		○	○	○	○	
	1/1000		○	○	○	○	
	1/2000		○	○	○	○	
	VARIABLE		○	○	○	○	
TALLY			○	○	○	○	
PREVIEW			○	×	×	×	
CALL			○	○	○	○	
BARS	OFF		○	○	○	○	
	ON		○	○	○	○	
DETAIL (CONTOUR)	OFF		○	○	○	○	
	ON		○	○	○	○	

Function		Connected Model	GY-DV550	KY-D29	KY-D29W	KY-27C KY-19
DETAIL LEVEL			○	○	○	○
DETAIL V/H BAL			○	×	△	×
DETAIL FREQUENCY	LOW		○	×	△	×
	MIDDLE		○	×	△	×
	HIGH		○	×	△	×
	AUTO		×	×	△	×
SKIN DETAIL	OFF		○	×	△	×
	ON		○	×	△	×
AUTO KNEE	OFF		○	○	○	○
	ON		○	○	○	○
KNEE POINT			○	×	×	×
COLOR MATRIX	OFF		○	×	△	×
	ON		○	×	△	×
V. RESOLUTION (HI-RESO)	NORMAL		○	○	○	×
	V. MAX		○	○	○	×
GAMMA	OFF		○	×	△	×
	ON		○	×	△	×
GAMMA LEVEL			○	○	○	×
BLACK	NORMAL		○	○	○	×
	STRETCH		○	○	○	×
	COMPRESS		○	○	○	×
ASPECT RATIO	4 : 3		○	×	△	×
	16 : 9		×	×	×	×
	LETTER		○	×	△	×
DNR	OFF		×	×	△	×
	ON		×	×	△	×
DNR LEVEL	LOW		×	×	△	×
	MIDDLE		×	×	△	×
	HIGH		×	×	△	×
	AUTO		×	×	△	×
SMOOTH TRANS	OFF		○	×	△	×
	ON		○	×	△	×
FULL AUTO	OFF		○	×	△	×
	ON		○	×	△	×
H. PHASE			○	○	○	○

○ : Available. × : Not available.
 △ : Connectable by modifying the KY-D29W. Consult your nearest JVC-authorized service agent for details.
 *1 Functions as AUTO WHITE with the KY-D29/KY-D29W.
 *2 Although this function is displayed it is not available.
 *3 The camera does not have a PVW lamp but the TALLY lamp on the RM-P210 lights in green.

GENERAL

TROUBLESHOOTING

	Symptom	Check Points	Page
Video troubles	Colors in the monitor screen are abnormal. (During genlocking)	<ul style="list-style-type: none"> • Is the SC phase adjusted properly? 	P. 13
	Synchronization is not possible.	<ul style="list-style-type: none"> • Are the BB or VBS signals applied to the GENLOCK INPUT connectors? • Is the VCR playback signal supplied directly without passing through a TBC? 	P. 13
Control troubles	Pressing the corresponding button cannot start the operation. <EXT> is displayed on the LCD.	<ul style="list-style-type: none"> • Functions that are not available on the camera cannot be controlled. Check the camera functions again. 	—
	The LCD display keeps on displaying "NOW INITIALIZING JUST A MOMENT" or "PLEASE CHECK THE CAMERA".	<ul style="list-style-type: none"> • Are cables connected properly? • Are the power switches of the RM-P210 and camera set to ON? • Is the MODE (RM/VTR) switch on the camera adapter set to "RM"? 	P. 8
	LCD display shows "----".	<ul style="list-style-type: none"> • The connected camera does not have the assigned function. Check the camera functions again and assign the proper functions to the F1 to F4 keys. 	P. 25
	White-balance adjustment cannot be started.	<ul style="list-style-type: none"> • Is the W.BAL switch set to A or B? • Is FAS or FAW ON (which is indicated by the lighting of the AUTO lamp)? 	P. 18
	White-balance adjustment will not complete.	<ul style="list-style-type: none"> • Are the color temperature filters and lighting conditions appropriate? • Does the object have colors? 	P. 18
	The tally lamp does not light.	<ul style="list-style-type: none"> • Is the tally system of the RM-P210 compatible with that of the camera system? The RM-P210 has been set at the factory in the "make contact mode". If it is required to set it to the "voltage supplied mode", the setting of the internal circuitry should be changed; consult your nearest JVC-authorized service agent. (The modification will then be carried out with charge.) 	P. 14
	Intercom is not possible.	<ul style="list-style-type: none"> • Is the headset impedance suitable? (Earphone: 50 Ω to 300 Ω/ 1 kHz. Microphone: Carbon). 	P. 14

SPECIFICATIONS

■ **Output Signals**

- Composite video signal:** 1 V(p-p), 75 Ω, 2 output
- R/G/B signals** : 0.7 V(p-p), 75 Ω, x 1 each (without sync)
- Y/R-Y/B-Y signals** : Y: 1 V(p-p), 75 Ω (including sync)
R-Y: 0.7 V(p-p), 75 Ω,
B-Y: 0.7 V(p-p), 75 Ω,
(75% color bar)
- Y/C signal** : Y: 1 V(p-p), 75 Ω (including sync)
C: 0.286 V(p-p), 75 Ω
(Burst level)
- Intercom** : 2-line system, -10 dB, 220 Ω, unbalanced, RTS (The RTS terminals are not designed to accept a power supply.)

■ **Input Signals**

- GENLOCK signal** : VBS, 1 V(p-p), or BB, 0.43 V(p-p) 75 Ω (Bridge connection possible)
- AUX signal** : VBS or VS, 1 V(p-p), 75 Ω (Bridge connection possible)
- Intercom** : 2-line system, -10 dB, 220 Ω, unbalanced, RTS (The RTS terminals are not designed to accept a power supply.)
- Tally** : Contact supply

■ **General**

- Input voltage** : 120 V AC, 60 Hz
- Power consumption** : 75 W (KY-D29W + VF-P550W)
- Mass** : 5.2 kg
- Operating temperatures:** -5°C to 45°C
- Accessory** : Power cord (2 m) x 1
Instructions x 1

■ **External Dimensions (Unit: mm)**

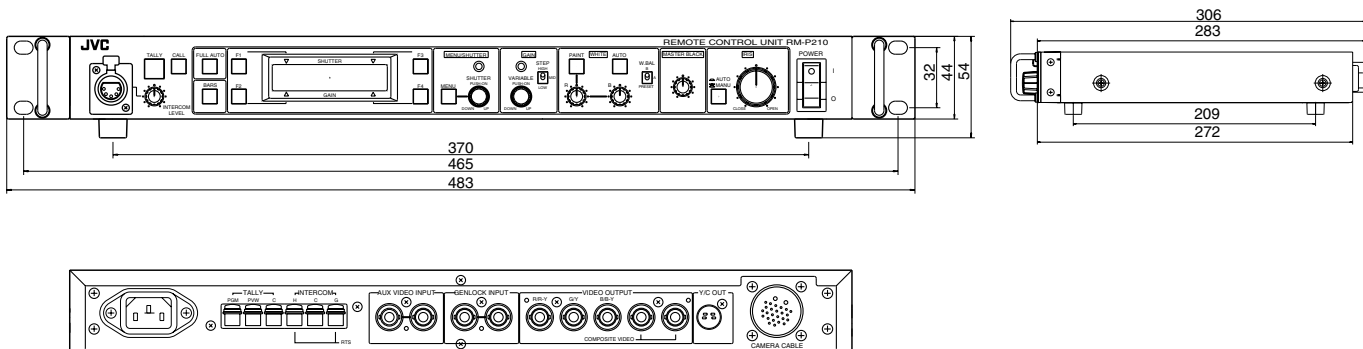

* Design and specifications are subject to change without notice.

JVC[®]